

DEVELON

Wheel Excavator

DX140W-7K



Engine

Make	HDI
Model	DL06P
Number of cylinders	6
Rated power, gross (hp per SAE J1995)	136.8 hp (102.0 kW) @ 2000 rpm
Rated power, net (hp per SAE J1349)	129.1 hp (96.3 kW) @ 2000 rpm
Max. torque, gross (SAE J1995)	433.7 ft.-lb. (588.0 Nm) @ 1400 rpm
Displacement	360.0 in. ³ (5.9 L)
Bore and stroke	3.9" x 4.9" (100 mm x 125 mm)
Starter	24 V, 8.0 hp (6.0 kW)
Battery	2 x 12 V, 150 AH
Alternator	24 V, 80 A
Air cleaner	Three-stage

Hydraulics

Main pumps	2 x 44.1 gpm (2 x 167.0 L/min.)
Pilot pump (gear design)	7.9 gpm (30.0 L/min.)

Working Pressure

Boom/arm/bucket (normal mode)	4978.2 psi (350.0 kg/cm ²)
Boom/arm/bucket (power boost)	5262.6 psi (370.0 kg/cm ²)
Travel	5262.6 psi (370.0 kg/cm ²)
Swing	3911.4 psi (275.0 kg/cm ²)
Pilot	583.2 psi (41.0 kg/cm ²)

Tires & Wheels (standard)

Type	Double
Tire specification	10.0 - 20 - 16 PR, OTR, TUBE
Rim specification	7.50 T x 20
Disc offset	155 mm

Swing Mechanism

Swing speed	0 - 12.2 rpm
Swing torque	34718.5 lbf.-ft. (4800.0 kgf-m)

Drive System

Travel speed (creep - low - high)	1.7 - 5.7 - 23.0 mph (2.7 - 9.2 - 37.0 km/h)
Traction force, max. (drawbar pull)	22707.6 lbf. (10300.0 kgf)
Max. grade (limited by engine lubrication)	53% (27.9°)

Environment

Sound level (2000/14/EC)	100 dB(A)
Cabin sound level (ISO 6396)	69 dB(A)

Refill Capacities

Fuel tank	72.6 gal. (275.0 L)
DEF tank	7.9 gal. (30.0 L)
Cooling system (radiator capacity)	7.8 gal. (29.4 L)
Engine oil (with filter)	5.8 gal. (22.0 L)
Swing drive	0.8 gal. (3.0 L)
Front axle	2.8 gal. (10.5 L)
Front hub (2x)	0.7 gal. (2.5 L)
Rear axle	3.7 gal. (14.0 L)
Rear hub (2x)	0.7 gal. (2.5 L)
Transmission	0.7 gal. (2.5 L)
Hydraulic system	44.9 gal. (170.0 L)
Hydraulic tank	23.8 gal. (90.0 L)

All capacities are approximate values. Always refer to the machine's OM for exact refill levels. Check the dipstick, level eye, level plug, etc., to achieve the correct level.

Technical Specifications

Hydraulic Cylinders

	Mono Boom (US20/30)	Articulated Boom (US40/50)
Boom main (2) bore x rod diameter x stroke	4.3" x 3.0" x 40.7" (110 mm x 75 mm x 1035 mm)	4.3" x 3.0" x 38.4" (110 mm x 75 mm x 975 mm)
Boom articulated (1) bore x rod diameter x stroke	–	5.5" x 3.3" x 28.6" (140 mm x 85 mm x 727 mm)
Arm* (1) bore x rod diameter x stroke	4.7" x 3.1" x 43.0" (120 mm x 80 mm x 1092 mm)	4.7" x 3.1" x 42.9" (120 mm x 80 mm x 1089 mm)
Bucket (STD) (1) bore x rod diameter x stroke	3.7" x 2.6" x 35.4" (95 mm x 65 mm x 900 mm)	3.9" x 2.8" x 35.4" (100 mm x 70 mm x 900 mm)
Steering (1) bore x rod diameter x stroke	3.5" x 2.0" x 3.8" (90 mm x 50 mm x 96 mm)	
Chocking (2) bore x rod diameter x stroke	3.9" x 3.9" x 6.0" (100 mm x 100 mm x 153 mm)	
Dozer (2) bore x rod diameter x stroke	3.9" x 2.4" x 8.0" (100 mm x 60 mm x 204 mm)	
Outrigger (2 or 4) bore x rod diameter x stroke	4.3" x 2.8" x 17.2" (110 mm x 70 mm x 438 mm)	

*Does not include cushioning

The piston rods and cylinder bodies are made of high-strength steel. A shock-absorbing mechanism is fitted in all cylinders to ensure shock-free operation and extended piston life.

Dimensions

		Mono Boom (U520)	(U530)	Articulated Boom (U540)	(U550)
Boom length		14' 5.2" (4400 mm)		16' 5.2" (5009 mm) Lower: 6' 6.7" (2000 mm), Upper: 10' 11.9" (3350 mm)	
Arm length		6' 10.7" (2100 mm)			
Bucket size (SAE)		0.77 yd ³ (0.59 m ³)		0.67 yd ³ (0.51 m ³)	
Shipping length	A	26' 4.7" (8043 mm)		26' 7.0" (8103 mm)	
Shipping width	B	8' 2.2" (2495 mm)			
Shipping height (hose)	C	9' 9.1" (2995 mm)		8' 9.8" (2688 mm)	
Shipping height (boom)	D	9' 4.0" (2845 mm)		8' 8.3" (2648 mm)	
Cabin height	E	10' 0.2" (3052 mm)			
Overall height to guardrail	F	10' 7.9" (3249 mm)			
Cabin height above house	G	2' 9.1" (840 mm)			
Tail swing radius	H	7' 5.9" (2283 mm)			
Car body clearance	I	1' 1.7" (348 mm)			
Counterweight clearance	J	3' 11.8" (1215 mm)			
Engine cover height	K	7' 3.1" (2212 mm)			
Upper structure width	L	8' 2.0" (2490 mm)			
Wheel base	M	9' 2.2" (2800 mm)			
Tread width	N	6' 4.5" (1944 mm)			
Tread width wide axle	O	-			
Driving length*		23' 8" (7219 mm)		20' 3" (6174 mm)	
Driving height (boom)*		12' 2" (3710 mm)		13' 1" (3988 mm)	
Driving height (hose)*		12' 2" (3710 mm)		12' 11" (3947 mm)	
Blade width*		8' 2.2" (2495 mm)	-	8' 2.2" (2495 mm)	-
Undercarriage width*		16' 3.1" (4957 mm)	16' 4.7" (4996 mm)	16' 3.1" (4957 mm)	16' 4.7" (4996 mm)
Outrigger length (rear)*		3' 7.7" (1109 mm)			
Outrigger length (front)*		-	3' 6.8" (1087 mm)	-	3' 6.8" (1087 mm)
Blade length*		3' 5.3" (1048 mm)	-	3' 5.3" (1048 mm)	-
Blade clearance (raised)*		1' 6.6" (472 mm)	-	1' 6.6" (472 mm)	-
Blade height*		2' 1.7" (652 mm)	-	2' 1.7" (652 mm)	-
Max. blade depth*		-5.0" (-128 mm)	-	-5.0" (-128 mm)	-
Outrigger width (ground)*		11' 11.0" (3631 mm)			
Outrigger width (max. depth)*		11' 2.1" (3406 mm)			
Max. outrigger depth*		-6.0" (-152 mm)			
Tire size*		10.0 - 20 - 16 PR			

*Not shown on diagram

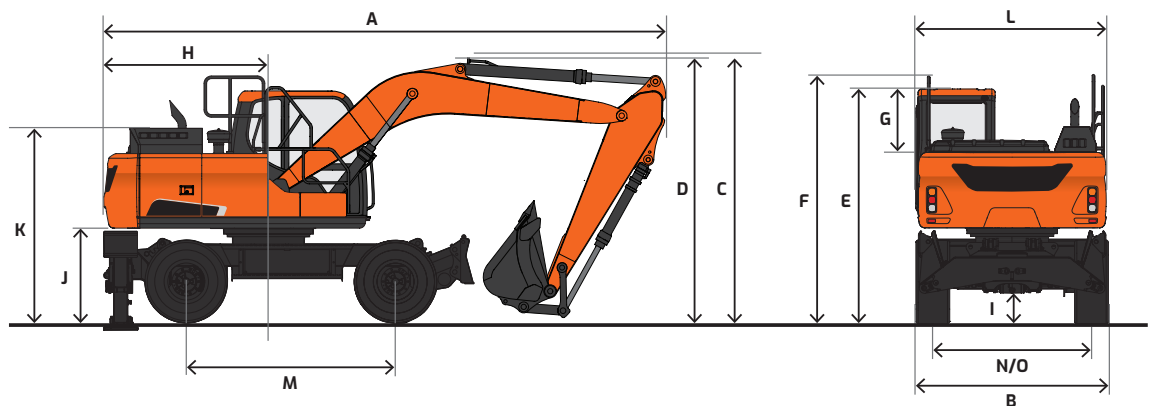

Working Range

	Mono Boom Dozer/Outriggers (2 R) (US20)		Articulated Boom Dozer/Outriggers (2 R) (US40)		
		Outriggers (2 F/2 R) (US30)		Outriggers (2 F/2 R) (US50)	
Boom length	14' 5.2" (4400 mm)		16' 5.2" (5009 mm) Lower: 6' 6.7" (2000 mm), Upper: 10' 11.9" (3350 mm)		
Boom articulated	-		6' 6.7" (2000 mm)		
Arm length	6' 10.7" (2100 mm)				
Bucket size (SAE)	0.77 yd ³ (0.59 m ³)		0.67 yd ³ (0.51 m ³)		
Counterweight	5500 lb. (2500 kg)				
Max. digging reach	A	24' 10.6" (7585 mm)	27' 0.4" (8240 mm)		
Max. digging reach (ground)	B	24' 2.4" (7375 mm)	26' 4.9" (8050 mm)		
Max. digging depth	C	14' 8.8" (4490 mm)	16' 5.8" (5025 mm)		
Max. loading height	D	19' 4.5" (5905 mm)	22' 3.5" (6795 mm)		
Min. loading height	E	-			
Max. digging height	F	26' 10.6" (8195 mm)	30' 0.2" (9150 mm)		
Max. bucket pin height	G	23' 4.5" (7125 mm)	26' 3.4" (8010 mm)		
Max. vertical wall depth	H	11' 3.6" (3445 mm)	12' 7.2" (3840 mm)		
Max. radius vertical	I	17' 11.7" (5480 mm)	19' 1.3" (5825 mm)		
Max. depth to 8' line	J	13' 9.9" (4215 mm)	16' 1.1" (4905 mm)		
Min. radius to 8' line	K	6' 10.9" (2105 mm)	2' 10.1" (865 mm)		
Min. digging reach	L	17.9" (455 mm)	-		
Min. swing radius	M	7' 8.1" (2340 mm)	8' 2.6" (2505 mm)		
Bucket angle (DEG)	d	173.7°			
Digging force, bucket (PCSA)*	ISO	23302.9 lbf. (10570 kgf)	24780.0 lbf. (11240 kgf)		
Digging force, arm*		19290.5 lbf. (8750 kgf)			
Operating weight		34670 lb. (15726 kg)	34811 lb. (15790 kg)	35025 lb. (15887 kg)	35166 lb. (15951 kg)

*With power boost ON

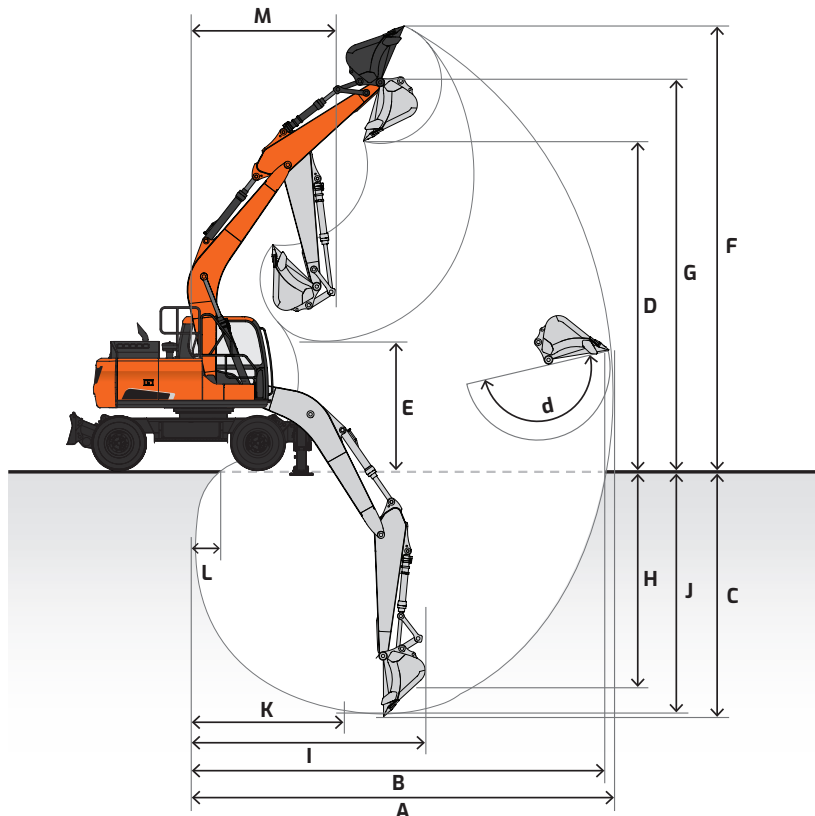











Lifting Capacity

 Rating over front  Rating over side or 360°











DX140W-7K US20

Mono Boom: 14' 5.2" (4400 mm) | Arm: 6' 10.7" (2100 mm) | Counterweight: 5500 lb. (2500 kg) | Front Dozer & Rear Outriggers UP | Bucket: None | Unit: lb. (kg)

B (ft. or m) A (ft. or m)	5' (1.5 m)		10' (3.0 m)		15' (4.5 m)		20' (6.0 m)		Max. Reach		A
											
25' (7.5 m)	* 14530 (* 6590)	* 14530 (* 6590)							* 9810 (* 4450)	* 9810 (* 4450)	8.41' (2.56 m)
20' (6.0 m)	* 12740 (* 5780)	* 12740 (* 5780)	* 13340 (* 6050)	* 13340 (* 6050)	* 9420 (* 4270)	* 9420 (* 4270)			* 7390 (* 3350)	* 7390 (* 3350)	15.44' (4.71 m)
15' (4.5 m)	* 13620 (* 6180)	* 13620 (* 6180)	* 16000 (* 7260)	* 16000 (* 7260)	* 14710 (* 6670)	9490 (4300)			* 6940 (* 3150)	6540 (2960)	18.81' (5.73 m)
10' (3.0 m)			* 25410 (* 11520)	16440 (7460)	17490 (7930)	9080 (4120)	* 10820 (* 4910)	5990 (2720)	* 7080 (* 3210)	5640 (2560)	20.48' (6.24 m)
5' (1.5 m)			* 24000 (* 10890)	15180 (6880)	16920 (7680)	8630 (3920)	10750 (4870)	5820 (2640)	* 7720 (* 3500)	5360 (2430)	20.88' (6.36 m)
Ground Level			* 25810 (* 11710)	14800 (6710)	16570 (7520)	8360 (3790)	10620 (4820)	5710 (2590)	* 9120 (* 4140)	5570 (2530)	20.07' (6.12 m)
-5' (-1.5 m)			* 26670 (* 12100)	14860 (6740)	16520 (7490)	8320 (3770)			12240 (5550)	6480 (2940)	17.90' (5.46 m)

DX140W-7K US20

Mono Boom: 14' 5.2" (4400 mm) | Arm: 6' 10.7" (2100 mm) | Counterweight: 5500 lb. (2500 kg) | Front Dozer & Rear Outriggers DOWN | Bucket: None | Unit: lb. (kg)

B (ft. or m) A (ft. or m)	5' (1.5 m)		10' (3.0 m)		15' (4.5 m)		20' (6.0 m)		Max. Reach		A
											
25' (7.5 m)	* 14530 (* 6590)	* 14530 (* 6590)							* 9810 (* 4450)	* 9810 (* 4450)	8.41' (2.56 m)
20' (6.0 m)	* 12740 (* 5780)	* 12740 (* 5780)	* 13340 (* 6050)	* 13340 (* 6050)	* 9420 (* 4270)	* 9420 (* 4270)			* 7390 (* 3350)	* 7390 (* 3350)	15.44' (4.71 m)
15' (4.5 m)	* 13620 (* 6180)	* 13620 (* 6180)	* 16000 (* 7260)	* 16000 (* 7260)	* 14710 (* 6670)	* 14710 (* 6670)			* 6940 (* 3150)	* 6940 (* 3150)	18.81' (5.73 m)
10' (3.0 m)			* 25410 (* 11520)	* 25410 (* 11520)	* 17680 (* 8020)	15140 (6870)	* 10820 (* 4910)	9690 (4390)	* 7080 (* 3210)	* 7080 (* 3210)	20.48' (6.24 m)
5' (1.5 m)			* 24000 (* 10890)	* 24000 (* 10890)	* 19990 (* 9070)	14620 (6630)	* 14580 (* 6610)	9500 (4310)	* 7720 (* 3500)	* 7720 (* 3500)	20.88' (6.36 m)
Ground Level			* 25810 (* 11710)	* 25810 (* 11710)	* 20590 (* 9340)	14290 (6480)	* 12470 (* 5660)	9380 (4260)	* 9120 (* 4140)	* 9120 (* 4140)	20.07' (6.12 m)
-5' (-1.5 m)			* 26670 (* 12100)	* 26670 (* 12100)	* 18520 (* 8400)	14250 (6460)			* 12350 (* 5660)	10750 (4880)	17.90' (5.46 m)

A Distance from center of rotation
B Height

NOTE: Lifting capacities are in compliance with SAE 1097 and ISO 10567. Machine in lifting mode with power boost turned on. Load point is the end of the arm. Rated loads shown do not exceed 75% of minimum tipping loads or 87% of hydraulic capacities. Rated loads marked with an asterisk (*) are limited by hydraulic capacities. The least stable position is over the side. The total mass of machine includes the mass of the boom, arm, counterweight, all operating fluids and 165 lb. (75 kg) operator.

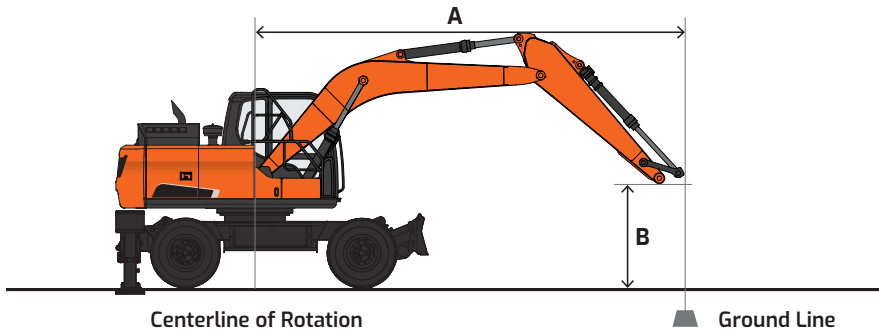













Lifting Capacity

 Rating over front  Rating over side or 360°













DX140W-7K US30

Mono Boom: 14' 5.2" (4400 mm) | Arm: 6' 10.7" (2100 mm) | Counterweight: 5500 lb. (2500 kg) | Front & Rear Outriggers UP | Bucket: None | Unit: lb. (kg)

B (ft. or m)	A (ft. or m)		5' (1.5 m)		10' (3.0 m)		15' (4.5 m)		20' (6.0 m)		Max. Reach		A
													
20' (6.0 m)					* 9420 (* 4270)	* 9420 (* 4270)					* 7390 (* 3350)	* 7390 (* 3350)	15.44' (4.71 m)
15' (4.5 m)					* 12730 (* 5770)	* 9530 (4320)					* 6930 (* 3150)	6570 (2980)	18.81' (5.73 m)
10' (3.0 m)			* 21020 (* 9540)	16520 (7500)	* 14590 (* 6620)	9130 (4140)	* 10820 (* 4910)	6020 (2730)	* 7080 (* 3210)	5670 (2570)			20.48' (6.24 m)
5' (1.5 m)			* 24000 (* 10890)	15270 (6920)	* 16470 (* 7470)	8680 (3940)	10690 (4850)	5860 (2660)	* 7720 (* 3500)	5400 (2450)			20.88' (6.36 m)
Ground Level			* 25400 (* 11520)	14890 (6760)	16490 (7480)	8410 (3810)	10560 (4790)	5750 (2610)	* 9120 (* 4140)	5610 (2540)			20.07' (6.12 m)
-5' (-1.5 m)	* 20330 (* 9220)	* 20330 (* 9220)	* 21900 (* 9940)	14950 (6780)	* 15190 (* 6890)	8370 (3800)			* 11640 (* 5280)	6520 (2960)			17.90' (5.46 m)
-10' (-3.0 m)			* 14670 (* 6660)	* 14670 (* 6660)					* 10180 (* 4620)	9570 (4340)			13.68' (4.17 m)

DX140W-7K US30

Mono Boom: 14' 5.2" (4400 mm) | Arm: 6' 10.7" (2100 mm) | Counterweight: 5500 lb. (2500 kg) | Front & Rear Outriggers DOWN | Bucket: None | Unit: lb. (kg)

B (ft. or m)	A (ft. or m)		5' (1.5 m)		10' (3.0 m)		15' (4.5 m)		20' (6.0 m)		Max. Reach		A
													
20' (6.0 m)					* 9420 (* 4270)	* 9420 (* 4270)					* 7390 (* 3350)	* 7390 (* 3350)	15.44' (4.71 m)
15' (4.5 m)					* 12730 (* 5770)	* 12730 (* 5770)					* 6930 (* 3150)	* 6930 (* 3150)	18.81' (5.73 m)
10' (3.0 m)			* 21020 (* 9540)	* 21020 (* 9540)	* 14590 (* 6620)	* 14590 (* 6620)	* 10820 (* 4910)	* 10820 (* 4910)	* 7080 (* 3210)	* 7080 (* 3210)			20.48' (6.24 m)
5' (1.5 m)			* 24000 (* 10890)	* 24000 (* 10890)	* 16470 (* 7470)	* 16470 (* 7470)	* 12510 (* 5670)	11420 (5180)	* 7720 (* 3500)	* 7720 (* 3500)			20.88' (6.36 m)
Ground Level			* 25400 (* 11520)	* 25400 (* 11520)	* 16940 (* 7690)	* 16940 (* 7690)	* 12200 (* 5540)	11300 (5120)	* 9120 (* 4140)	* 9120 (* 4140)			20.07' (6.12 m)
-5' (-1.5 m)	* 20330 (* 9220)	* 20330 (* 9220)	* 21900 (* 9940)	* 21900 (* 9940)	* 15190 (* 6890)	* 15190 (* 6890)			* 11640 (* 5280)	* 11640 (* 5280)			17.90' (5.46 m)
-10' (-3.0 m)			* 14670 (* 6660)	* 14670 (* 6660)					* 10180 (* 4620)	* 10180 (* 4620)			13.68' (4.17 m)

A Distance from center of rotation
B Height

NOTE: Lifting capacities are in compliance with SAE 1097 and ISO 10567. Machine in lifting mode with power boost turned on. Load point is the end of the arm. Rated loads shown do not exceed 75% of minimum tipping loads or 87% of hydraulic capacities. Rated loads marked with an asterisk (*) are limited by hydraulic capacities. The least stable position is over the side. The total mass of machine includes the mass of the boom, arm, counterweight, all operating fluids and 165 lb. (75 kg) operator.

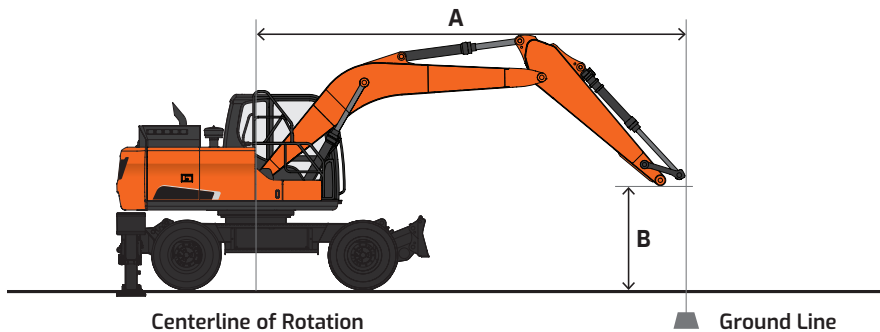













Lifting Capacity

 Rating over front  Rating over side or 360°













DX140W-7K US40

2-PC Boom: 16' 5.2" (5000 mm) | Arm: 6' 10.7" (2100 mm) | Counterweight: 5500 lb. (2500 kg) | Front Dozer & Rear Outriggers UP | Bucket: None | Unit: lb. (kg)

B (ft. or m)	A (ft. or m)		5' (1.5 m)		10' (3.0 m)		15' (4.5 m)		20' (6.0 m)		Max. Reach		
													
25' (7.5 m)											* 10040 (* 4560)	* 10040 (* 4560)	12.92' (3.94 m)
20' (6.0 m)					* 10440 (* 4740)	9650 (4380)					* 8510 (* 3860)	6850 (3110)	18.24' (5.56 m)
15' (4.5 m)			* 14840 (* 6730)	* 14840 (* 6730)	* 11590 (* 5260)	9340 (4230)	* 10240 (* 4650)	6030 (2730)	* 8140 (* 3690)	5350 (2430)			21.16' (6.45 m)
10' (3.0 m)					* 13800 (* 6260)	8760 (3970)	10850 (4920)	5820 (2640)	* 8290 (* 3760)	4710 (2140)			22.66' (6.91 m)
5' (1.5 m)					* 15790 (* 7160)	8220 (3730)	10580 (4800)	5590 (2540)	8380 (3800)	4490 (2040)			23.02' (7.02 m)
Ground Level					16210 (7350)	7940 (3600)	10440 (4720)	5440 (2470)	8700 (3950)	4630 (2100)			22.29' (6.79 m)
-5' (-1.5 m)			* 21590 (* 9790)	14280 (6480)	* 15460 (* 7010)	7910 (3590)	10440 (4720)	5440 (2470)	9930 (4510)	5230 (2370)			20.35' (6.20 m)

DX140W-7K US40

2-PC Boom: 16' 5.2" (5000 mm) | Arm: 6' 10.7" (2100 mm) | Counterweight: 5500 lb. (2500 kg) | Front Dozer & Rear Outriggers DOWN | Bucket: None | Unit: lb. (kg)

B (ft. or m)	A (ft. or m)		5' (1.5 m)		10' (3.0 m)		15' (4.5 m)		20' (6.0 m)		Max. Reach		
													
25' (7.5 m)											* 10040 (* 4560)	* 10040 (* 4560)	12.92' (3.94 m)
20' (6.0 m)					* 10440 (* 4740)	* 10440 (* 4740)					* 8510 (* 3860)	* 8510 (* 3860)	18.24' (5.56 m)
15' (4.5 m)			* 14840 (* 6730)	* 14840 (* 6730)	* 11590 (* 5260)	* 11590 (* 5260)	* 10240 (* 4650)	9800 (4450)	* 8140 (* 3690)	* 8140 (* 3690)			21.16' (6.45 m)
10' (3.0 m)					* 13800 (* 6260)	* 13800 (* 6260)	* 10990 (* 4980)	9570 (4340)	* 8290 (* 3760)	7730 (3500)			22.66' (6.91 m)
5' (1.5 m)					* 15790 (* 7160)	14240 (6460)	* 11820 (* 5360)	9310 (4220)	* 8920 (* 4050)	7430 (3370)			23.02' (7.02 m)
Ground Level					* 16430 (* 7450)	13910 (6310)	* 12100 (* 5490)	9140 (4150)	* 10210 (* 4630)	7700 (3490)			22.29' (6.79 m)
-5' (-1.5 m)			* 21590 (* 9790)	* 21590 (* 9790)	* 15460 (* 7010)	13880 (6300)	* 11130 (* 5050)	9150 (4150)	* 10500 (* 4760)	8750 (3970)			20.35' (6.20 m)

A Distance from center of rotation
B Height

NOTE: Lifting capacities are in compliance with SAE 1097 and ISO 10567. Machine in lifting mode with power boost turned on. Load point is the end of the arm. Rated loads shown do not exceed 75% of minimum tipping loads or 87% of hydraulic capacities. Rated loads marked with an asterisk (*) are limited by hydraulic capacities. The least stable position is over the side. The total mass of machine includes the mass of the boom, arm, counterweight, all operating fluids and 165 lb. (75 kg) operator.

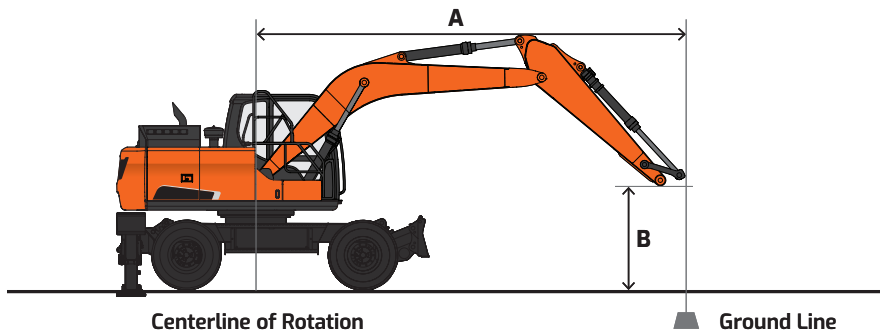













Lifting Capacity

 Rating over front  Rating over side or 360°













DX140W-7K US50

2-PC Boom: 16' 5.2" (5000 mm) | Arm: 6' 10.7" (2100 mm) | Counterweight: 5500 lb. (2500 kg) | Front & Rear Outriggers UP | Bucket: None | Unit: lb. (kg)

B (ft. or m)	A (ft. or m)		5' (1.5 m)		10' (3.0 m)		15' (4.5 m)		20' (6.0 m)		Max. Reach		
													
25' (7.5 m)											* 10040 (* 4560)	* 10040 (* 4560)	12.92' (3.94 m)
20' (6.0 m)					* 10440 (* 4740)	9700 (4400)					* 8510 (* 3860)	6890 (3120)	18.24' (5.56 m)
15' (4.5 m)			* 14840 (* 6730)	* 14840 (* 6730)	* 11590 (* 5260)	9390 (4260)	* 10240 (* 4650)	6060 (2750)	* 8140 (* 3690)		5380 (2440)		21.16' (6.45 m)
10' (3.0 m)					* 13800 (* 6260)	8810 (4000)	10800 (4900)	5860 (2660)	* 8290 (* 3760)		4740 (2150)		22.66' (6.91 m)
5' (1.5 m)					* 15790 (* 7160)	8270 (3750)	10530 (4770)	5620 (2550)	8330 (3780)		4520 (2050)		23.02' (7.02 m)
Ground Level					16130 (7320)	7990 (3620)	10350 (4690)	5470 (2480)	8660 (3930)		4660 (2110)		22.29' (6.79 m)
-5' (-1.5 m)			* 21590 (* 9790)	14370 (6520)	* 15460 (* 7010)	7960 (3610)	10350 (4700)	5480 (2480)	9880 (4480)		5260 (2390)		20.35' (6.20 m)

DX140W-7K US50

2-PC Boom: 16' 5.2" (5000 mm) | Arm: 6' 10.7" (2100 mm) | Counterweight: 5500 lb. (2500 kg) | Front & Rear Outriggers DOWN | Bucket: None | Unit: lb. (kg)

B (ft. or m)	A (ft. or m)		5' (1.5 m)		10' (3.0 m)		15' (4.5 m)		20' (6.0 m)		Max. Reach		
													
25' (7.5 m)											* 10040 (* 4560)	* 10040 (* 4560)	12.92' (3.94 m)
20' (6.0 m)					* 10440 (* 4740)	* 10440 (* 4740)					* 8510 (* 3860)	* 8510 (* 3860)	18.24' (5.56 m)
15' (4.5 m)			* 14840 (* 6730)	* 14840 (* 6730)	* 11590 (* 5260)	* 11590 (* 5260)	* 10240 (* 4650)	* 10240 (* 4650)	* 8140 (* 3690)		* 8140 (* 3690)		21.16' (6.45 m)
10' (3.0 m)					* 13800 (* 6260)	* 13800 (* 6260)	* 10990 (* 4980)	* 10990 (* 4980)	* 8290 (* 3760)		* 8290 (* 3760)		22.66' (6.91 m)
5' (1.5 m)					* 15790 (* 7160)	* 15790 (* 7160)	* 11820 (* 5360)	11260 (5110)	* 8920 (* 4050)		* 8920 (* 4050)		23.02' (7.02 m)
Ground Level					* 16430 (* 7450)	* 16430 (* 7450)	* 12100 (* 5490)	11080 (5030)	* 10210 (* 4630)		9270 (4210)		22.29' (6.79 m)
-5' (-1.5 m)			* 21590 (* 9790)	* 21590 (* 9790)	* 15460 (* 7010)	* 15460 (* 7010)	* 11130 (* 5050)	11080 (5030)	* 10500 (* 4760)		* 10500 (* 4760)		20.35' (6.20 m)

A Distance from center of rotation
B Height

NOTE: Lifting capacities are in compliance with SAE 1097 and ISO 10567. Machine in lifting mode with power boost turned on. Load point is the end of the arm. Rated loads shown do not exceed 75% of minimum tipping loads or 87% of hydraulic capacities. Rated loads marked with an asterisk (*) are limited by hydraulic capacities. The least stable position is over the side. The total mass of machine includes the mass of the boom, arm, counterweight, all operating fluids and 165 lb. (75 kg) operator.

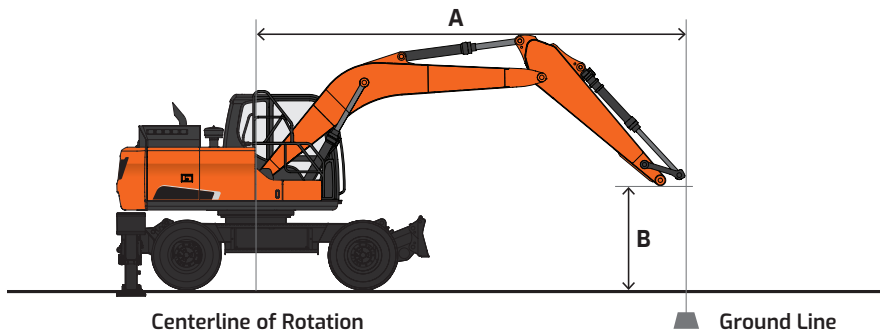

Standard & Optional Equipment

■ Standard ● Optional

Engine

Emissions (EPA), T4f	■
High-pressure common-rail (HPCR)	■
Turbo, waste gate (WGT)	■
Cooled exhaust gas recirculation (CEGR)	■
Diesel oxidation catalyst (DOC)	■
Selective catalytic reduction (SCR)	■
Diesel exhaust fluid (DEF)	■
Fuel filter with water separator	■
Coolant expansion tank	■
Dual element dry-type air filter with evacuator	■
Precleaner	■
Electronic engine control (ECU)	■
Auto idle	■
Auto shutdown (time-adjustable)	■
Overheat & low oil pressure engine protection	■
Water separator with heater	■

Hydraulic

Mechatronics Design	■
Variable axial piston main pump (tandem)	■
Cross-sensing pump control	■
Pilot-operated control valves	■
Gear pilot pump	■
Smart Power Control (SPC)	■
Variable-speed hydraulic cooling fan (engine-driven with electric clutch)	■
Axial piston swing motor	■
Spring-applied hydraulic release brake (swing motor)	■
Axial piston travel motor (high/low, auto)	■
Auxiliary hydraulics, one-way piping	■
Auxiliary hydraulics, tilt/rotate piping	■
Adjustable auxiliary flow & pressure, 10 presets	■
Boom & arm lock valves	●
Overload warning device (OWD)	●
Load Isolation System (Ride Control)	■

Electrical

System voltage – 24 V	■
Alternator – 24 V, 80 A	■
2 x 12 V batteries, 150 AH reserve capacity, 950 CCA	■
Blade-type fuse panel	■
Main circuit breaker	■
Lights, work (LED): machine (2), boom (2)	■
Lights, work (LED): 6 cab top, front (4), rear (2)	●
Lights, work (LED): 4 cab top, front (2), rear (2)	●
Rotating beacon	■
Hour meter	■
Engine restart prevention system	■
Rearview camera	■
Smart around view camera, 360°	●
Radar	●
Laptop service port	■
Self-diagnostics system	■
Smart Key (remote ignition key)	■
MY DEVELON (telematics)	■

Cabin

Steel, all-weather & sound-suppressed	■
ROPS (ISO 12117-2:2008)	■
Viscous mount with spring reinforcement	■
Front window with panto wiper/washer	■
Tinted safety glass	■
Skylight top hatch with sun screen	■
Visor, front window skylight & rear window	■
Pull-up type top front window	■
Removable lower front window with storage behind seat	■
Adjustable sliding side door window	■
Defrost, front window	■
Lockable doors	■
Leatherette seat	■
- Heating & cooling	■
- Air-suspension	■
- 2" (51 mm) seat belt	■
- Adjustable height & recline	■
- Adjustable fore/aft	■
- Adjustable armrests	■
Control stands	■
- Height adjustable	■
- Mounted to seat base	■
Foot rest	■
Storage for operator's manuals	■
Rearview mirrors	■
Fully automatic HVAC with ambient temperature sensor	■
12" DEVELON Smart Touch display monitor	■
Digital Bluetooth® & MP3 radio with cell phone integration	■
Speakers (2)	■
Antenna, roof-mounted	■
Emergency breakout tool	■
Hot/cold beverage compartment	■
Power socket, 12 V & 24 V	■
Cup holder	■
Interior light	■
Coat hanger	■

Display Monitor & Warnings

Indicators	■
- Work modes (P+, P, S, E)	■
- User/Service menu	■
Gauges	■
- Fuel level	■
- DEF level	■
- Engine coolant temperature	■
- Hydraulic oil temperature	■
- Engine rpm	■
- Battery voltage	■
- Hydraulic pump pressure	■
- ECO	■
- Digital clock	■
- Trip meter	■
- Hour meter	■
- Fuel consumption	■
Warning & indicator lights	■
- Seat belt	■
- Error code	■
- SCR warning	■
- Check engine	■
- Engine oil pressure	■
- Engine pre-heat engaged	■
- Radiator coolant level & temperature	■
- Air filter	■
- Fuel level	■
- DEF level – low	■
- Water in fuel	■
- Battery charge	■
- Work lights on	■
- Hydraulic oil temperature	■
- Hydraulic charge pressure	■
- Hydraulic pilot filter	■
- Hydraulic return filter	■
Swing alarm	■
Travel alarm	■
Buzzer	■
- Engine oil pressure	■
- Coolant temperature	■

Controls

Steering wheel	■
Accelerator pedal	■
Brake pedal	■
Swing lock mechanism for traveling	■
Fine swing control	■
Joystick controls	■
Pattern control change valve (SAE, ISO BHL)	■
Joystick attachment control, switches/buttons	■
- Right (one-way, two-way, power boost)	■
- Left (tilt/rotate, horn, one-touch decel)	■
Foot pedal attachment control	■
Control stands	■
- Height adjustable	■
- Sliding (fore/aft)	■
- Tilting armrests	■
Engine speed control dial	■
Switches & indicators, steering column	■
- Steering column	■
- Positional lever	■
- Work/travel selector switch	■
- Turn signal control lever	■
- Hazard warning switch	■
- Turn signal/hazard light indicators	■
- Wiper & washer control	■
- Horn button	■
- High/low beam control	■
Switches, console-mounted	■
- Starter button switch	■
- Travel speed selector	■
- Work light	■
- Auxiliary mode switch	■
Emergency stop switch	■
Power modes (P+, P, S, E)	■
Work modes (digging, lifting, breaker, shear)	■
Jog dial display control	■
Wiper control panel	■
Audio control panel	■
Joystick steering	■

Undercarriage

Tire size – 10.0 – 20 – 16 ply rating	■
Transmission: 2-speed power-shift with creep	■
Planetary drive front & rear axle	■
Oscillating (±B°) front axle, lockable	■
Steering front axle	■
Dozer	■
Outriggers, front (in place of dozer)	●
Outriggers, rear	■
Toolbox	■

Other

Centralized lubrication	■
- Boom	■
- Swing	■
Emergency steering	■
Handrails & service platforms	■
Skid-resistant steps & service platforms	■
Wheel chocks	■
Manuals	■
- Operation & Maintenance	■
- AEM Safety Manual	■
MY DEVELON 3-year subscription (telematics)	■
Vandalism protection	■
- Lockable panels	■
- Lockable fluid fill points	■
- Anti-theft protection (password)	■
- Window cover mount	■

Certain specification(s) are based on engineering calculations and are not actual measurements. Specification(s) are provided for comparison purposes only and are subject to change without notice. Specification(s) for your individual DEVELON equipment will vary based on normal variations in design, manufacturing, operating conditions, and other factors. Pictures of DEVELON units may show other than standard equipment.

Powered by Innovation

DEVELON

A brand of HD Hyundai Infracore.

na.develon-ce.com/dx140w-7k

DX140W-7K Wheel Excavator Spec Sheet
Printed in the U.S.A.
25164_002_D091525

©2025 HD Hyundai Infracore. All rights reserved.