

DEVELON

Crawler Excavator

DX140LC-7K



Engine

Make	DEVELON
Model	G2 DM03 - D34
Number of cylinders	4
Rated power, gross (hp per SAE J1995)	115.3 hp (86.0 kW) @ 2000 rpm
Rated power, net (hp per SAE J1349)	107.3 hp (80.0 kW) @ 2000 rpm
Max. torque, gross (SAE J1995)	339.3 ft.-lb. (460.0 Nm) @ 1400 rpm
Displacement	207.5 in. ³ (3.4 L)
Bore and stroke	3.9" x 4.4" (98 mm x 113 mm)
Starter	24 V, 6.7 hp (5.0 kW)
Battery	2 x 12 V, 100 AH
Alternator	24 V, 100 A
Air cleaner	Two-stage

Hydraulics

Main pumps	2 x 30.1 gpm (2 x 114.0 L/min.)
Pilot pump (gear design)	7.9 gpm (30.0 L/min.)

Working Pressure

Boom/arm/bucket (normal mode)	4693.7 psi (330.0 kg/cm ²)
Boom/arm/bucket (power boost)	4978.2 psi (350.0 kg/cm ²)
Travel	4978.2 psi (350.0 kg/cm ²)
Swing	3911.4 psi (275.0 kg/cm ²)
Pilot	568.9 psi (40.0 kg/cm ²)

Undercarriage

Upper rollers (each track)	1
Lower rollers (each track)	7
Number of shoes (links per side)	46

Swing Mechanism

Swing speed	0 - 10.1 rpm
Swing torque	35355.0 lbf.-ft. (4888.0 kgf-m)

Drive System

Travel speed (low - high)	1.8 - 2.9 mph (2.9 - 4.7 km/h)
Traction force, max. (drawbar pull)	33510.3 lbf. (15200.0 kgf)
Max. grade (limited by engine lub)	70% (35°)

Environment

Sound level (2000/14/EC)	100 dB(A)
Cabin sound level (ISO 6396)	69 dB(A)

Refill Capacities

Fuel tank	68.7 gal. (260.0 L)
DEF tank	6.6 gal. (25.0 L)
Cooling system (radiator capacity)	4.7 gal. (17.9 L)
Engine oil (with filter)	3.3 gal. (12.6 L)
Swing drive	0.8 gal. (3.0 L)
Final drive (each side)	0.5 gal. (2.0 L)
Hydraulic system	44.9 gal. (170.0 L)
Hydraulic tank	25.6 gal. (97.0 L)

All capacities are approximate values. Always refer to the machine's OM for exact refill levels. Check the dipstick, level eye, level plug, etc., to achieve the correct level.

Hydraulic Cylinders

Boom ¹ (2) bore x rod diameter x stroke	4.3" x 3.0" x 42.7" (110 mm x 75 mm x 1085 mm)
Arm ^{1,2} (1) bore x rod diameter x stroke	4.5" x 3.1" x 43.6" (115 mm x 80 mm x 1108 mm)
Bucket ¹ (1) bore x rod diameter x stroke	3.9" x 2.8" x 35.4" (100 mm x 70 mm x 900 mm)

¹ Cushion on rod end

² Cushion on base end

The piston rods and cylinder bodies are made of high-strength steel. A shock-absorbing mechanism is fitted in all cylinders to ensure shock-free operation and extended piston life.

NOTE: Where applicable, dimensions are in accordance with Society of Automotive Engineers (SAE) and ISO standards. Specifications and design are subject to change without notice. All dimensions are given for DEVELON excavators equipped with standard tracks and the standard front as listed. Pictures of DEVELON excavators may show other than standard equipment. All dimensions are shown in inches. Respective metric dimensions are enclosed by parentheses. Rounding may impact specifications. DEVELON equipment is manufactured with a Quality Management System that is in compliance with ISO 9001:2008.

Dimensions

		Standard Arm 23.6" (600 mm) TG Shoe (US20)	Standard Arm & Dozer Blade 23.6" (600 mm) TG Shoe (US40)
Boom length		15' 1.1" (4600 mm)	
Arm length		9' 10.1" (3000 mm)	
Bucket size (SAE)		0.67 yd ³ (0.51 m ³)	
Tail swing radius	A ₁	7' 4.4" (2246.4 mm)	
Tail swing overhang (rear)	A ₂	1' 2.5" (369 mm)	
Tail swing overhang (side)	A ₃	3' 1.4" (951 mm)	
Shipping height (boom)	B	10' 0.7" (3065 mm)	
Shipping height (hose)	C	10' 5.2" (3180 mm)	
Shipping length	D	25' 2.4" (7680 mm)	
Shipping width	E	8' 6.0" (2590 mm)	
Counterweight clearance*	F	2' 10.2" (868.5 mm)	
Cabin height	G	9' 3.0" (2818.7 mm)	
Upper structure width	H	8' 4.0" (2540 mm)	
Cabin height above house	I	2' 8.2" (816.9 mm)	
Cabin width	J	3' 4.4" (1026.4 mm)	
Tumbler distance	K	9' 11.4" (3034 mm)	
Overall track length	L	12' 3.8" (3754.3 mm)	
Undercarriage width	M	8' 6.0" (2590 mm)	
Track gauge width	N	6' 6.3" (1990 mm)	
Track shoe width	O	23.6" (600 mm)	
Track height*	P	2' 5.3" (743 mm)	
Car body clearance*	Q	1' 3.0" (381.5 mm)	

*Without shoe grouser

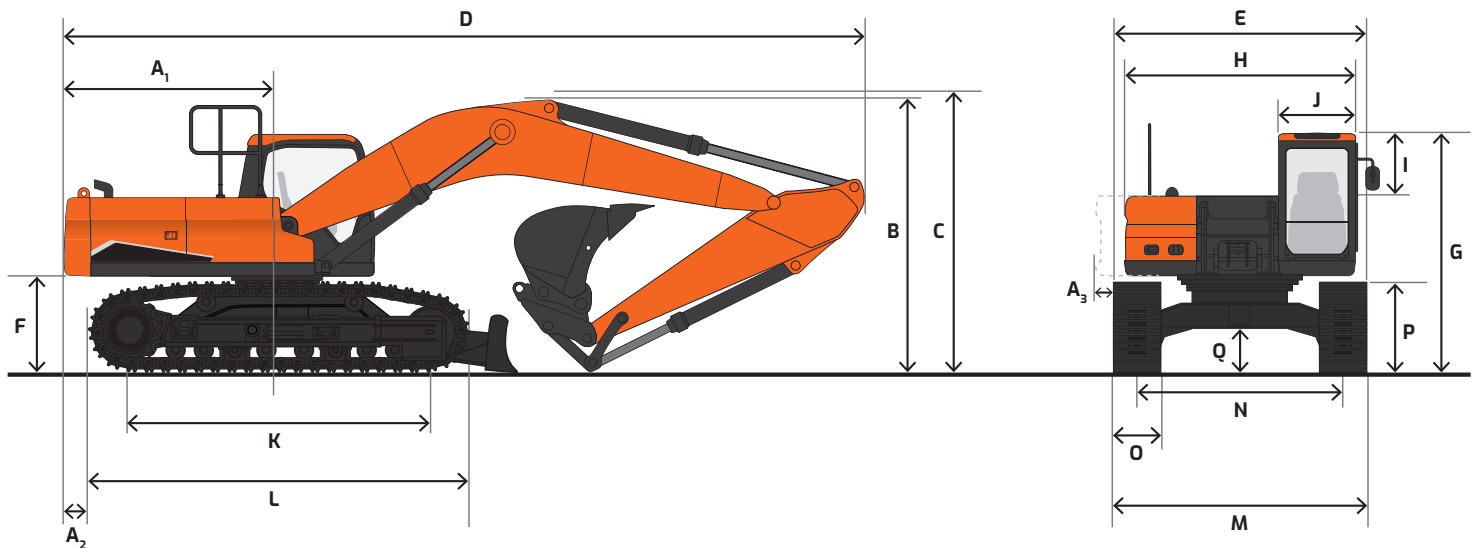

Working Range

		Standard Arm 23.6" (600 mm) TG Shoe (US20)	Standard Arm & Dozer Blade 23.6" (600 mm) TG Shoe (US40)
Boom length		15' 1.1" (4600 mm)	
Arm length		9' 10.1" (3000 mm)	
Bucket size (SAE)		0.67 yd ³ (0.51 m ³)	
Counterweight		4850 lb. (2200 kg)	
Track type		Fixed	
Max. digging reach	A	28' 5.1" (8665 mm)	
Max. digging reach (ground)	B	27' 11.8" (8530 mm)	
Max. digging depth	C	20' 1.5" (6135 mm)	
Max. loading height	D	21' 1.5" (6440 mm)	
Min. loading height	E	5' 7.9" (1725 mm)	
Max. digging height	F	28' 8.3" (8745 mm)	
Max. bucket pin height	G	25' 1.4" (7655 mm)	
Max. vertical wall depth	H	15' 4.4" (4685 mm)	
Max. radius vertical	I	19' 7.0" (5970 mm)	
Max. depth to 8' line	J	19' 3.9" (5890 mm)	
Min. radius to 8' line	K	5' 11.9" (1825 mm)	
Min. digging reach	L	-8.9" (-225 mm)	
Min. swing radius	M	8' 7.3" (2625 mm)	
Bucket angle (DEG)	d	174°	
Digging force, bucket*	ISO	24471.3 lbf. (11100.0 kgf)	
Digging force, arm*		13227.7 lbf. (6000.0 kgf)	
Operating weight		31747 lb. (14400 kg)	34092 lb. (15464 kg)
Ground pressure		5.3 psi (0.37 kg/cm ²)	5.5 psi (0.39 kg/cm ²)

*With power boost ON

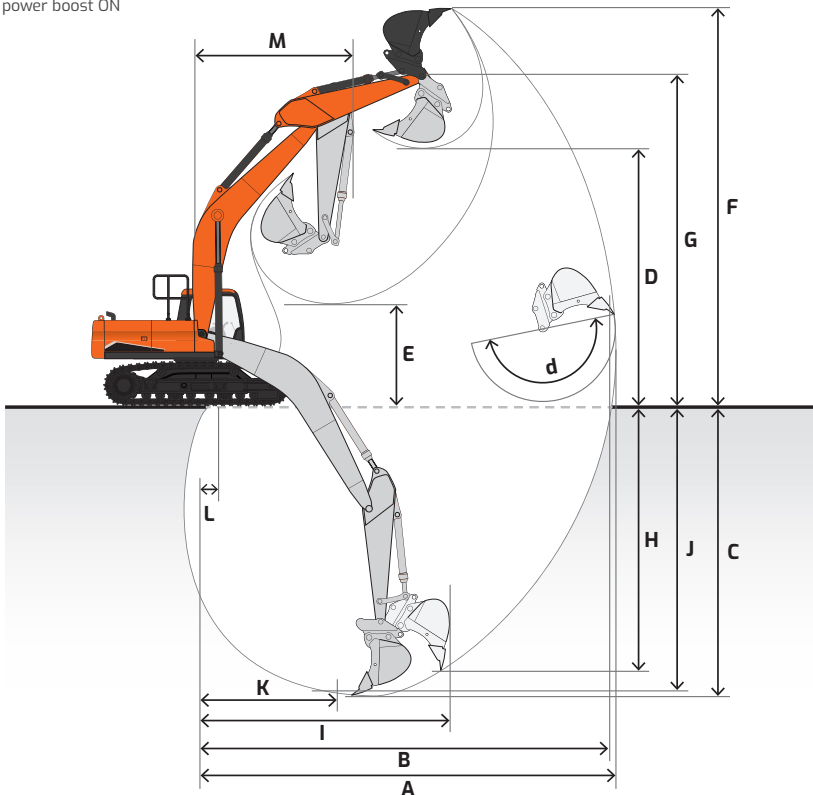













Lifting Capacity

 Rating over front  Rating over side or 360°

DX140LC-7K US20

Boom: 15' 1.1" (4600 mm) | Arm: 9' 10.1" (3000 mm) | Counterweight: 4850 lb. (2200 kg) | 23.6" (600 mm) TG Shoes | No Dozer | Bucket: None | Unit: lb. (kg)

B (ft. or m)	A (ft. or m)		5' (1.5 m)		10' (3.0 m)		15' (4.5 m)		20' (6.0 m)		Max. Reach		A
													
25' (7.5 m)											* 5330 (* 2420)	* 5330 (* 2420)	14.24' (4.34 m)
20' (6.0 m)											* 4510 (* 2050)	* 4510 (* 2050)	19.4' (5.91 m)
15' (4.5 m)					* 7390 (* 3350)	* 7390 (* 3350)	* 7060 (* 3200)	5610 (2550)	* 4280 (* 1940)	* 4280 (* 1940)	* 4280 (* 1940)	* 4280 (* 1940)	22.35' (6.81 m)
10' (3.0 m)			* 11910 (* 5400)	* 11910 (* 5400)	* 9640 (* 4370)	8470 (3840)	8150 (3700)	5420 (2460)	* 4320 (* 1960)	3930 (1780)	3930 (1780)	3930 (1780)	23.95' (7.30 m)
5' (1.5 m)			* 19610 (* 8890)	14400 (6530)	12340 (* 5600)	7870 (3570)	7870 (3570)	5170 (2340)	* 4590 (* 2080)	3710 (1680)	3710 (1680)	3710 (1680)	24.44' (7.45 m)
Ground Level			* 18400 (* 8350)	13420 (6090)	11810 (5360)	7410 (3360)	7630 (3460)	4950 (2240)	* 5170 (* 2340)	3750 (1700)	3750 (1700)	3750 (1700)	23.91' (7.29 m)
-5' (-1.5 m)	* 11460 (* 5200)	* 11460 (* 5200)	* 22310 (* 10120)	13180 (5980)	11560 (5240)	7190 (3260)	7510 (3400)	4840 (2190)	* 6290 (* 2850)	4100 (1860)	4100 (1860)	4100 (1860)	22.28' (6.79 m)
-10' (-3.0 m)	* 18060 (* 8190)	* 18060 (* 8190)	* 22920 (* 10400)	13330 (6050)	11590 (5260)	7220 (3270)			7810 (3540)	5050 (2290)	5050 (2290)	5050 (2290)	19.27' (5.87 m)
-15' (-4.5 m)			* 17480 (* 7930)	13850 (6280)					* 11800 (* 5350)	8210 (3720)	8210 (3720)	8210 (3720)	13.95' (4.25 m)

A Distance from center of rotation
B Height

NOTE: Lifting capacities are in compliance with SAE 1097 and ISO 10567. Machine in lifting mode with power boost turned on. Load point is the end of the arm. Rated loads shown do not exceed 75% of minimum tipping loads or 87% of hydraulic capacities. Rated loads marked with an asterisk (*) are limited by hydraulic capacities. The least stable position is over the side. The total mass of machine includes the mass of the boom, arm, counterweight, all operating fluids and 165 lb. (75 kg) operator.

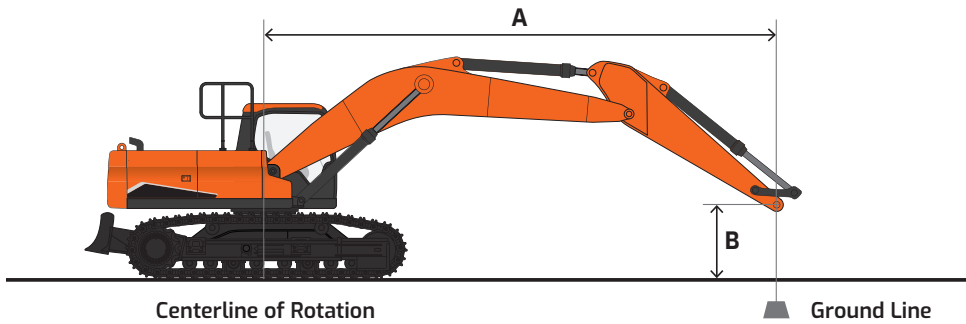













Lifting Capacity

 Rating over front  Rating over side or 360°

DX140LC-7K US40

Boom: 15' 1.1" (4600 mm) | Arm: 9' 10.1" (3000 mm) | Counterweight: 4850 lb. (2200 kg) | 23.6" (600 mm) TG Shoes | Dozer Up | Bucket: None | Unit: lb. (kg)

B (ft. or m)	A (ft. or m)		5' (1.5 m)		10' (3.0 m)		15' (4.5 m)		20' (6.0 m)		Max. Reach		A
													
25' (7.5 m)											* 5330 (* 2420)	* 5330 (* 2420)	14.24' (4.34 m)
20' (6.0 m)											* 4510 (* 2050)	* 4510 (* 2050)	19.4' (5.91 m)
15' (4.5 m)					* 7390 (* 3350)	* 7390 (* 3350)	* 7060 (* 3200)	5990 (2720)	* 4280 (* 1940)	* 4280 (* 1940)	* 4280 (* 1940)	* 4280 (* 1940)	22.35' (6.81 m)
10' (3.0 m)			* 11910 (* 5400)	* 11910 (* 5400)	* 9640 (* 4370)	9010 (4090)	8130 (3690)	5800 (2630)	* 4320 (* 1960)	4230 (1920)	4230 (1920)	4230 (1920)	23.95' (7.30 m)
5' (1.5 m)			* 19610 (* 8890)	15360 (6970)	12310 (5580)	8410 (3820)	7850 (3560)	5550 (2520)	* 4590 (* 2080)	4000 (1810)	4000 (1810)	4000 (1810)	24.44' (7.45 m)
Ground Level			* 18400 (* 8350)	14380 (6520)	11770 (5340)	7950 (3610)	7610 (3450)	5320 (2410)	* 5170 (* 2340)	4050 (1840)	4050 (1840)	4050 (1840)	23.91' (7.29 m)
-5' (-1.5 m)	* 11460 (* 5200)	* 11460 (* 5200)	* 22310 (* 10120)	14140 (6420)	11530 (5230)	7730 (3510)	7480 (3390)	5210 (2360)	6290 (2850)	4420 (2010)	4420 (2010)	4420 (2010)	22.28' (6.79 m)
-10' (-3.0 m)	* 18060 (* 8190)	* 18060 (* 8190)	* 22920 (* 10400)	14290 (6480)	11560 (5240)	7760 (3520)			7790 (3530)	5430 (2460)	5430 (2460)	5430 (2460)	19.27' (5.87 m)
-15' (-4.5 m)			* 17480 (* 7930)	14810 (6720)					* 11800 (* 5350)	8790 (3990)	8790 (3990)	8790 (3990)	13.95' (4.25 m)

A Distance from center of rotation
B Height

NOTE: Lifting capacities are in compliance with SAE 1097 and ISO 10567. Machine in lifting mode with power boost turned on. Load point is the end of the arm. Rated loads shown do not exceed 75% of minimum tipping loads or 87% of hydraulic capacities. Rated loads marked with an asterisk (*) are limited by hydraulic capacities. The least stable position is over the side. The total mass of machine includes the mass of the boom, arm, counterweight, all operating fluids and 165 lb. (75 kg) operator.

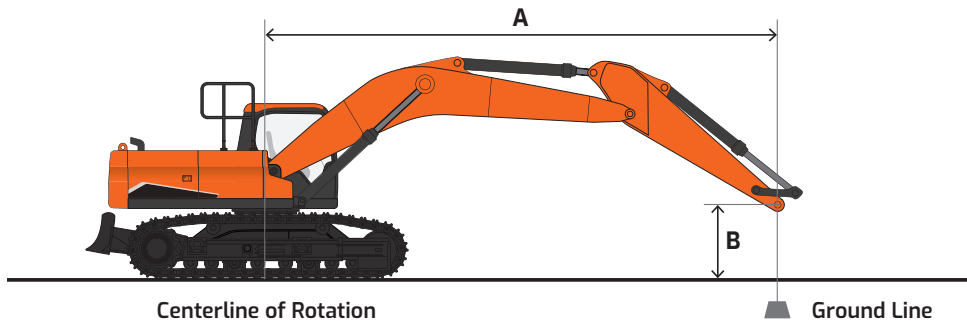











Lifting Capacity

 Rating over front  Rating over side or 360°

DX140LC-7K US40

Boom: 15' 1.1" (4600 mm) | Arm: 9' 10.1" (3000 mm) | Counterweight: 4850 lb. (2200 kg) | 23.6" (600 mm) TG Shoes | Dozer Down | Bucket: None | Unit: lb. (kg)

A (ft. or m) B (ft. or m)	5' (1.5 m)		10' (3.0 m)		15' (4.5 m)		20' (6.0 m)		Max. Reach		
											A
25' (7.5 m)									* 5330 (* 2420)	* 5330 (* 2420)	14.24' (4.34 m)
20' (6.0 m)									* 4510 (* 2050)	* 4510 (* 2050)	19.4' (5.91 m)
15' (4.5 m)					* 7390 (* 3350)	* 7390 (* 3350)	* 7060 (* 3200)	* 7060 (* 3200)	* 4280 (* 1940)	* 4280 (* 1940)	22.35' (6.81 m)
10' (3.0 m)			* 11910 (* 5400)	* 11910 (* 5400)	* 9640 (* 4370)	* 9640 (* 4370)	* 8710 (* 3950)	7270 (3300)	* 4320 (* 1960)	* 4320 (* 1960)	23.95' (7.30 m)
5' (1.5 m)			* 19610 (* 8890)	* 19610 (* 8890)	* 12600 (* 5720)	10750 (4880)	* 10050 (* 4560)	7000 (3170)	* 4590 (* 2080)	* 4590 (* 2080)	24.44' (7.45 m)
Ground Level			* 18400 (* 8350)	* 18400 (* 8350)	* 14990 (* 6800)	10250 (4650)	* 11240 (* 5100)	6770 (3070)	* 5170 (* 2340)	5130 (2330)	23.91' (7.29 m)
-5' (-1.5 m)	* 11460 (* 5200)	* 11460 (* 5200)	* 22310 (* 10120)	19300 (8760)	* 16010 (* 7260)	10020 (4550)	* 11740 (* 5330)	6650 (3020)	* 6290 (* 2850)	5620 (2550)	22.28' (6.79 m)
-10' (-3.0 m)	* 18060 (* 8190)	* 18060 (* 8190)	* 22920 (* 10400)	19470 (8830)	* 15260 (* 6920)	10050 (4560)			* 8880 (* 4030)	6920 (3140)	19.27' (5.87 m)
-15' (-4.5 m)			* 17480 (* 7930)	* 17480 (* 7930)					* 11800 (* 5350)	11350 (5150)	13.95' (4.25 m)

A Distance from center of rotation
B Height

NOTE: Lifting capacities are in compliance with SAE 1097 and ISO 10567. Machine in lifting mode with power boost turned on. Load point is the end of the arm. Rated loads shown do not exceed 75% of minimum tipping loads or 87% of hydraulic capacities. Rated loads marked with an asterisk (*) are limited by hydraulic capacities. The least stable position is over the side. The total mass of machine includes the mass of the boom, arm, counterweight, all operating fluids and 165 lb. (75 kg) operator.

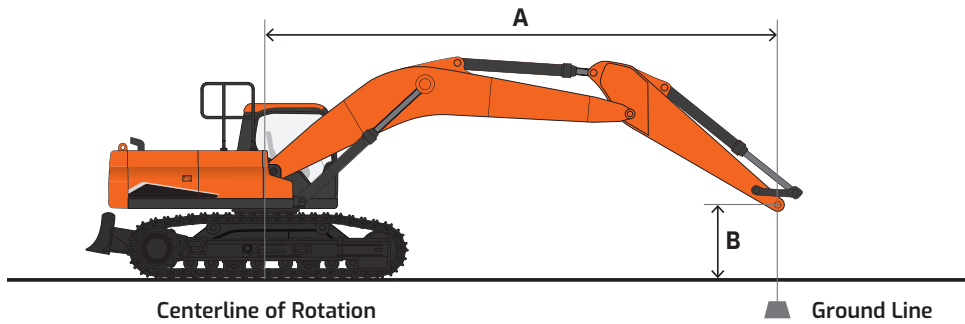

Standard & Optional Equipment

■ Standard • Optional

Engine

Emissions (EPA), T4f	■
High-pressure common-rail (HPCR)	■
Turbo, waste gate (WGT)	■
Diesel oxidation catalyst (DOC)	■
Selective catalytic reduction (SCR)	■
Diesel exhaust fluid (DEF)	■
Fuel filter with water separator	■
Coolant expansion tank	■
Dual element dry-type air filter with evacuator	■
Electronic engine control (ECU)	■
Auto idle	■
Auto shutdown (time-adjustable)	■
Overheat & low oil pressure engine protection	■
Water separator with heater	■
Fuel filler pump	•

Hydraulic

Mechatronics Design	■
Variable axial piston main pump (tandem)	■
Cross-sensing pump control	■
Pilot-operated control valves	■
Gear pilot pump	■
Smart Power Control (SPC)	■
Variable-speed hydraulic cooling fan	■
Axial piston swing motor	■
Spring-applied hydraulic release brake	■
Axial piston travel motor (high/low, auto)	■
Auxiliary hydraulics, one- & two-way piping	■
Auxiliary hydraulics, tilt/rotate piping	•
Adjustable auxiliary flow & pressure, 10 presets	■
Intelligent floating boom	■
Breaker filter	•
Boom & arm lock valves	•
Clamshell piping	•
Straight travel	■

Controls

Joystick controls	■
Pattern control change valve (SAE, ISO)	■
Joystick attachment control, switches/buttons - Right (one-way, two-way, power boost) - Left (tilt/rotate, horn, one-touch decel)	■
Foot pedal attachment control	■
Control stands - Height adjustable - Sliding (fore/aft) - Tilting armrests	■
Engine speed control dial	■
Travel pedals with hand levers	■
Straight travel pedal	■
Switches, console-mounted - Starter button switch - Travel speed selector - Work light - Auxiliary mode switch	■
Emergency stop switch	■
Power modes (P+, P, S, E)	■
Work modes (digging, lifting, breaker, shear)	■
Smart Power Control (SPC)	■
Jog dial display control	■
Wiper control panel	■
Audio control panel	■

Cabin

Steel, all-weather & sound-suppressed	■
ROPS (ISO 12117-2:2008)	■
Viscous mount with spring reinforcement	■
Front window with wiper/washer	■
Tinted safety glass	■
Skylight top hatch with sun screen	■
Front window with sun screen	■
Pull-up type top front window	■
Removable lower front window with storage behind seat	■
Wiper, lower window	■
Adjustable sliding side door window	■
Defrost, front window	■
Lockable doors	■
Seat - Heated - Air-suspension - 2" (51 mm) seat belt - Adjustable height & recline - Adjustable fore/aft - Adjustable armrests	■
Leatherette seat - Heating & cooling - Air-suspension - 2" (51 mm) seat belt - Adjustable height & recline - Adjustable fore/aft - Adjustable armrests	•
Control stands - Height adjustable - Mounted to seat base	■
Storage for operator's manuals	■
Mirrors	■
Fully automatic HVAC with radian energy photo sensor	■
8" multi-function LCD interactive display monitor	■
Cigarette lighter	■
Digital Bluetooth® & MP3 radio with cell phone integration	■
Speakers (2)	■
Antenna, roof-mounted	■
Emergency breakout tool	■
Hot/cold beverage compartment	■
Power socket, 12 V & 24 V	■
Cup holder	■
Interior light	■
Coat hanger	■
Rain shield	•
FOG guard	•
Front window guard	•

Electrical

System voltage – 24 V	■
Alternator – 24 V, 100 A	■
2 x 12 V batteries, 100 AH reserve capacity, 900 CCA	■
Blade-type fuse panel	■
Main circuit breaker	■
Light, work (LED): machine (2), boom (2)	■
Light, work (LED): 6 cab top, front (4), rear (2)	•
Light, work (LED): 4 cab top, front (2), rear (2)	•
Rotating beacon	■
Overload warning alarm	•
Hour meter	■
Engine restart prevention system	■
Side view & rearview camera with LED lamps (3)	■
Around view camera	•
Microphone & speaker	•
Ultrasonic sensor	•
Laptop service port	■
Self-diagnostics system	■
Smart Key (remote ignition key)	■
MY DEVELON (telematics)	■

Display Monitor & Warnings

Indicators - Power modes - Work modes - User/Service menu	■
Gauges - Fuel level - DEF level - Engine coolant temperature - Hydraulic oil temperature - Engine rpm - Battery voltage - Hydraulic pump pressure - ECO - Digital clock - Trip meter - Hour meter - Fuel consumption	■
Warning & indicator lights - Seat belt - Error code - SCR warning - Check engine - Engine oil pressure - Engine pre-heat engaged - Radiator coolant level & temperature - Air filter - Fuel level - DEF level – low - Water in fuel - Battery charge - Work lights on - Hydraulic oil temperature - Hydraulic charge pressure - Hydraulic pilot filter - Hydraulic return filter	■
Swing alarm	■
Travel alarm	■
Buzzer - Engine oil pressure - Coolant temperature	■

Undercarriage

Track guards & chains with adjusters	■
Track rollers, upper	1
Track rollers, lower	7
In-shoe motor protection	■
Shoes, triple grouser – 500 mm, rubber shoe (road liner)	•
Shoes, triple grouser – 500 mm	•
Shoes, triple grouser – 600 mm	■
Shoes, triple grouser – 700 mm	•
Dozer blade, front	•

Other

Centralized lubrication - Boom - Swing	■
Handrails & service platforms	■
Skid-resistant steps & service platforms	■
Manuals - Operation & Maintenance - AEM Safety Manual	■
MY DEVELON 3-year subscription (telematics)	■
Vandalism protection - Lockable panels - Lockable fluid fill points - Anti-theft protection (password) - Window cover mount	■
Air compressor	•

Certain specification(s) are based on engineering calculations and are not actual measurements. Specification(s) are provided for comparison purposes only and are subject to change without notice. Specification(s) for your individual DEVELON equipment will vary based on normal variations in design, manufacturing, operating conditions, and other factors. Pictures of DEVELON units may show other than standard equipment.

Powered by Innovation

DEVELON

A brand of HD Hyundai Infracore.

na.develon-ce.com/dx140lc-7k

DX140LC-7K Crawler Excavator Spec Sheet
Printed in the U.S.A.
23906_002_D083024

©2024 HD Hyundai Infracore. All rights reserved.